





### Options Overview

The option designation specifies the features that are available in your LAUFEN bathtub.

					
	Air massage	Water massage	Automatic disinfection	LED light	Fog function
Option 605	●				
Option 615*				●	
Option 616**				●	
Option 625*	●			●	
Option 627**	●			●	●
Option 635		●			
Option 645	●	●			
Option 675*	●	●		●	
Option 695*	●	●	●	●	

\* LED = 

\*\* LED = 



The warranty/liability only applies when the installation is effected as per the instructions by qualified personnel.

General Information	2
Care Instructions	3
Whirl Tub Components	4
Technical Data	4
Preliminary Operations	5
Function Description (Air Massage, Water Massage, LED Light, Fog function, Automatic Disinfection, Manual Disinfection)	6
Malfunctions	11
Service Instructions	12

## General Information

Dear customer,

Thank you for choosing a LAUFEN bathtub with whirl system.

Each bathtub with whirl system has been individually tested and must meet strict technical requirements, guaranteeing the quality of the materials used and the functioning of all the components.

In this user manual, you will find instructions, tips and suggestions which will help you to get the most out of your bathtub with whirl system. It is recommended that you read this manual carefully. If you require any further information, please contact your LAUFEN distributor.

### General comments

For the installation of your bathtub with whirl system, please follow the mounting instructions which were provided separately to this user manual. The water massage system must be supplied with sufficient ventilation. If the bathtub is installed with a panel, a gap of at least 10 mm must be left between the panel and the floor. This gap may not be blocked with towels, bath mats or similar since it guarantees perfect ventilation.

### Safety

While installing the bathtub, a series of simple steps must be followed in order to prevent possible accidents. The installation must be carried out by qualified technicians. Please follow the instructions included in the installation manual that has also been provided with the bathtub. The bathtub must be connected to a voltage of 230 V AC at 50 Hz. The appliance must be supplied through a residual current device (RCD), having a rated residual operating current that does not exceed 30 mA. Additionally, the electrical installation should be equipped with an electrical switch to ensure all-pole disconnection from the power supply. An equipotential connection must be made between the metallic elements of the bath, in accordance with the corresponding regulations of each country.

**Changes allowed:** LAUFEN reserves the right to make changes or modifications on any of its products without notice.  
**Different language versions of the user handbook can be found on the enclosed data carrier.**

## General Information



### Warning

- Let out the water after each bath.
- People with limited mobility should take extra care when using the bathtub with whirl system.
- Small children should not be allowed to use the whirlpool unless they are properly supervised.
- Use only diluted essences, perfumes and bath salts. Employ only products that are specifically approved for bathtubs with whirl systems.
- Regular disinfection guarantees hygienic bathing:
  - First disinfection: a first disinfection is to be run before using the whirlpool bath for the first time.
  - Recommended regular disinfection cycle: after using the bath 3 times, run the disinfection procedure (regular germ killing).
  - After a long period of non-use: after about 3 weeks of non-use of the whirlpool bath, it should likewise be disinfected before reuse.
- Parts containing live components, except parts supplied with safety extra-low voltage not exceeding 12 V, must be inaccessible to a person in the bath.
- Parts incorporating electrical components, except remote control devices, must be located or fixed so that they cannot fall into the bath.
- The RCD of the electrical installation has to be tested according to guidance of testing and resetting.
- Please make sure that all manuals delivered with the bathtub will be available to subsequent owners and users.
- The bathtub has to be set up or repaired only by installers who can demonstrate to the appropriate authorities awareness and competence in the application of National Regulatory requirements for safety, i. e. electrical and water supply/disposal.
- The use of a whirlpool bath can lower the blood pressure and stimulate circulation. Persons with circulatory problems should therefore firstly ask their family doctor, who can give tips as to the best way of using the bath.

## Care Instructions



### Bathtub Care

The surface is simple to clean and maintain. The smooth surface hardly collects dirt. Regular care: Sponge, soft cloth, somewhat antistatic cleaning agent. The tub will thus retain its gloss and reject dirt.

To clean your massage tub, please use a soft sponge, liquid soap and water. Rub dry with a dry cloth.

Avoid the use of abrasives or solvents which damage the surface of the tub. Because of their concentration, we recommend you do without such cleaning agents.

Remove heavy dirt with liquid household cleaner e. g. dishwash detergents or liquid soap (observe dilution instructions).

Remove lime marks with a decalcifier. Always rinse with plenty of clean water. Give a final polish with a soft cloth. Do not use acid cleaning agents or cleaning vinegar.

### Damage

Scratched surfaces should be treated by the specialist. Buff with a solvent-free polishing paste. If necessary, the surface can firstly be rubbed down with wet emery paper (No. 800, followed by No. 1200) before being polished. **In no case are alcohol or solvents containing acetone to be used.**

Damage resulting from inappropriate treatment by the user will not be covered by our guarantee.

### Electronic sensor control

The electronic sensor control operates air massage, water massage and coloured LED light. The automatic bathtub disinfection (option 695 only) is operated by the electronic sensor control, too. The touch sensor is integrated into the sanitary acrylic. So the control is extremely hygienic, easy to clean and scratch-proof.

To use the sensor buttons, touch the according pictogram slowly with the whole finger. If you touch the sensor button too fast, use only a part of your finger or touch it only slightly, you will not get any effect.

### Air massage

The air massage system has air vents that are integrated into the bottom of the bathtub. Ozoned warm air reaches the water via air ducts under the bottom of the tub and through the air outlet holes. The system is extremely hygienic and easy to maintain. The air ducts have their own water-drainage channel leading to the drain so that they are always completely emptied. The LAUFEN air massage system runs no risks on aging. The blower fan turns on automatically after each use of the whirlpool bath in order to dry the air ducts, even if you use the bath only for showering.

### Water massage

Unlike the air massage system, the water massage system uses water jets to achieve the desired massage effects. Depending on the model, your bath may feature between 10 and 14 massage water nozzles. There are six water nozzles at the sides of the bathtub. Their direction and intensity can be changed either via a touch sensor or manually. Rotary micronozzles are installed in the back and foot areas of the bathtub and can be varied in intensity. Generally, it is not recommended to direct the nozzles perpendicular to the body but rather at a slight angle.

### LED light

The LED lighting provides a special light effect to give your bathtub the pleasure of chromo-therapy. This light produces a relaxed atmosphere in your tub, which increases your feeling of well-being whether combined with air massage or not. The innovative RGB LED technology produces extremely strong light effects with small dimension, flat design and low power consumption. The user can select between a cycle of six colours and the direct selection of individual colours. The colours are: white, yellow, orange, blue, green and red.

### Automatic disinfection (only on Option 695)

The LAUFEN bathtub uses an automatic disinfection cycle for cleaning and germ killing. It can be started using a corresponding sensor button and applies a disinfection liquid to the tub.

### Misting function

The misting function serves to increase relaxation. The mist can be enriched with essential wellness essences which can be ordered using the Item No. 2.9980.0.000.0000.1. Four different aromas stimulate the body and spirit in different ways. They are added to the distilled water in the ration of 1:20. Please make sure to use only distilled water in order to prevent scale formation in the lines. Drain the tank regularly and fill with fresh distilled water. The LEDs of the sensor on the rim of the bath indicate when the contents of the tank have been used up and need to be replenished. Additional instructions can be seen on Page 9.

## Technical Data

### Total power

Option 605	- 0,77 kW
Option 615	- 0,01 kW
Option 616	- 0,10 kW
Option 625	- 0,78 kW
Option 627	- 0,88 kW
Option 635	- 0,84 kW
Option 645	- 1,62 kW
Option 675	- 1,63 kW
Option 695	- 1,63 kW

### Air massage blowers

Power 750 W  
(450 W for blowers  
+ 300 W for heating and  
ozoniser for disinfection)  
230 V AC 50/60 Hz

### Water massage pump

Power 1300 W  
230 V AC 50 Hz

### LED light

RGB LED spotlight:  
power 1 W  
5 V DC  
EN 60825-1:2003  
IPX8

RGB LED strip:  
power 1 W  
12 V DC  
EN 60825-1:2003  
IPX8

**Filling the bathtub**

LAUFEN bathtubs with whirl system are equipped with a safety device that prevents the operation of the water massage if the water level in the bathtub is too low, thus preventing the motor from overheating. For this reason it must be ensured that the water level covers the highest water nozzle by at least 20 mm before using the water massage system – see picture 1.

**First disinfection**

A first disinfection has to be run before using the bathtub with whirl system for the first time. Please see detailed instructions in the chapter about disinfection later on.

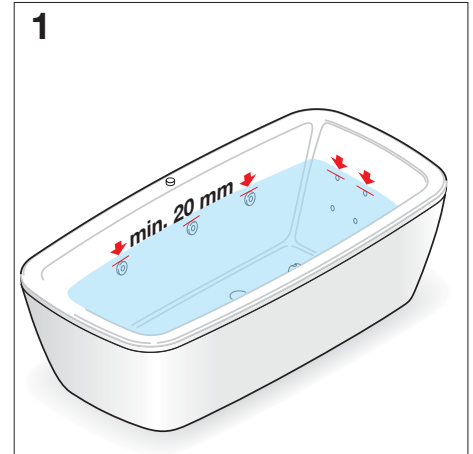

**Types of water massage nozzles**

Every bathtub with whirl system incorporates two different types of water massage nozzles: side jets and back jets. The side jets are available in a basic and an exclusive version. Depending on your bathtub model, different jet types and variable number of nozzles are present.

**Adjusting the exclusive side jets**

In order to adjust the side jets, direct the nozzles towards the part of the body that you want to have massaged. Simply move the nozzle to the desired direction – see picture 2. The intensity of the water massage can be adjusted manually or via the electronic sensor control (as described later on). Simply turn the nozzle clockwise for less intensity and anti-clockwise for more intensity as shown in picture 3. The changes of intensity for the exclusive side jets are gradual and you feel a slight latching resistance while turning the nozzle.

**Adjusting the basic side jets**

In order to adjust the side jets, direct the nozzles towards the part of the body that you want to have massaged. Simply move the nozzle to the desired direction – see picture 4. The intensity of the water massage can be adjusted manually or via the electronic sensor control (as described later on). Simply turn the the cover of the basic side jet clockwise for less intensity and anti-clockwise for more intensity as shown in picture 4. The intensity changes continuously.

**Adjusting the back jets**

The direction of the jets on the backrest cannot be adjusted, whereas you can change its intensity continuously by turning the nozzle.

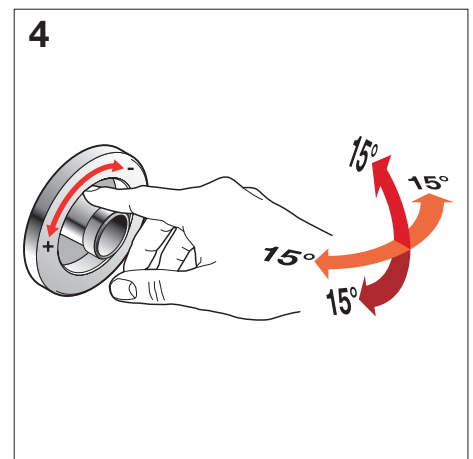
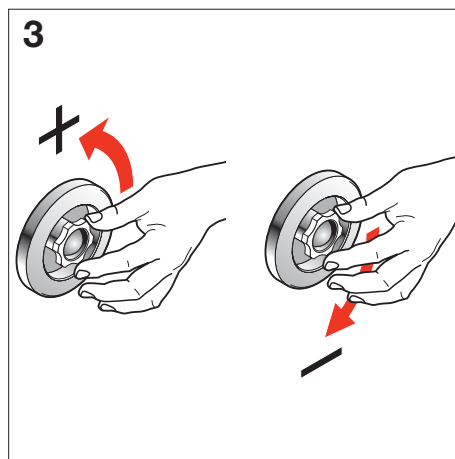
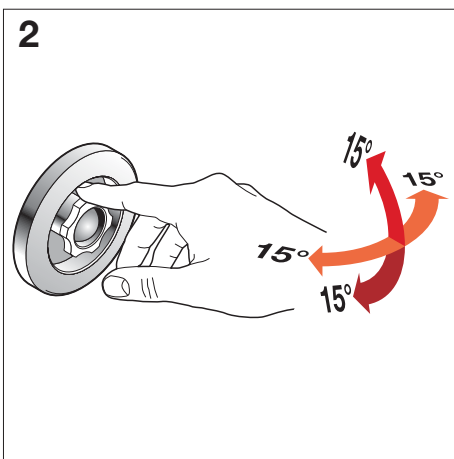

## Air Massage

### ON



After turning the air massage on, the intensity is set to minimum level.

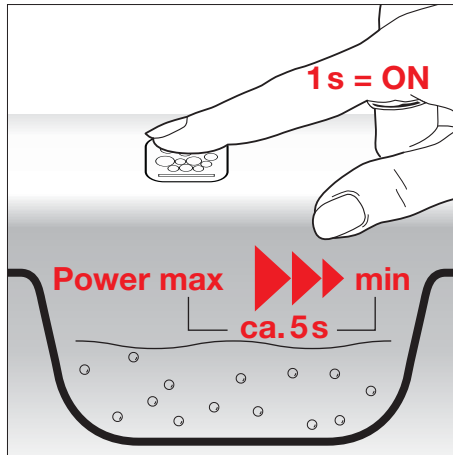

### Increase intensity

Press the button for more than 3 seconds. The intensity will be set to maximum level.

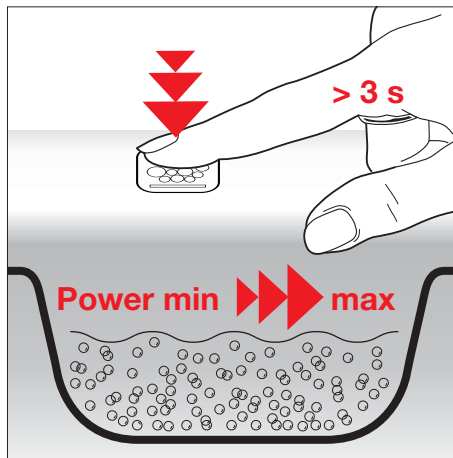

### Decrease intensity

Press the button once again and keep it pressed for more than 3 seconds to decrease the intensity. Release the button when the desired intensity is reached.

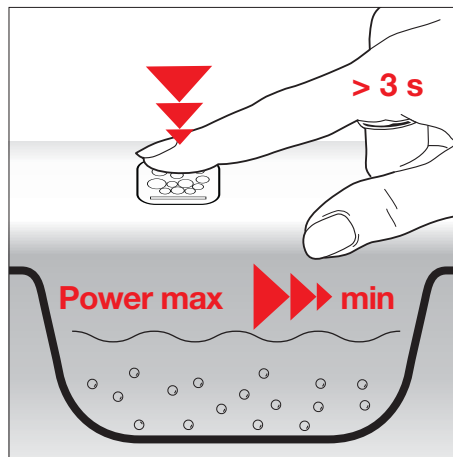

### OFF

Notes:

The air massage turns automatically off after 20 minutes of operation.

The blowers turn on automatically after each use of the whirlpool bath in order to dry the air ducts, even if you use the bath only for showering.

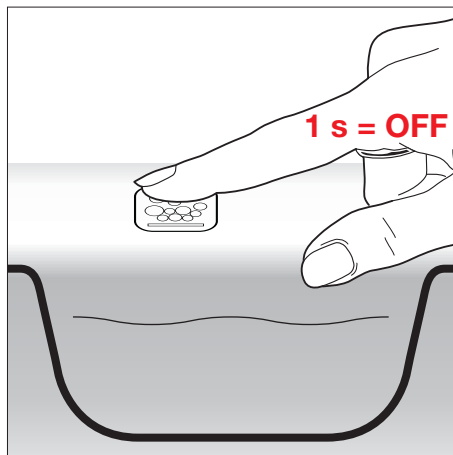

## Water Massage

### ON



After turning the water massage on, the intensity is set to minimum level.

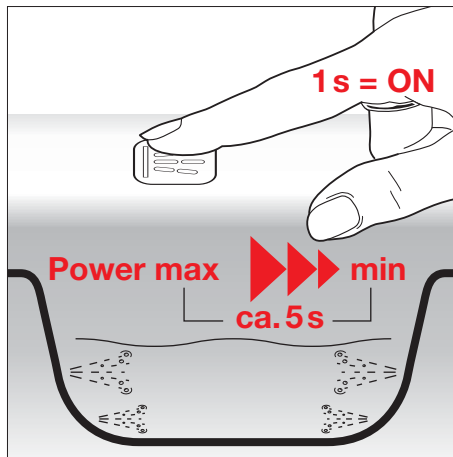

### Increase intensity

Press the button for more than 3 seconds. The intensity will be set to maximum level.

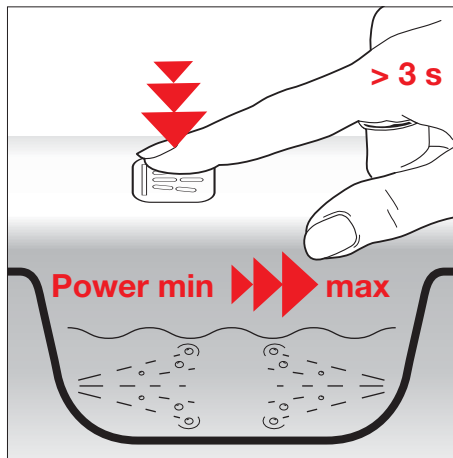

### Decrease intensity

Press the button once again and keep it pressed for more than 3 seconds to decrease the intensity. Release the button when the desired intensity is reached.

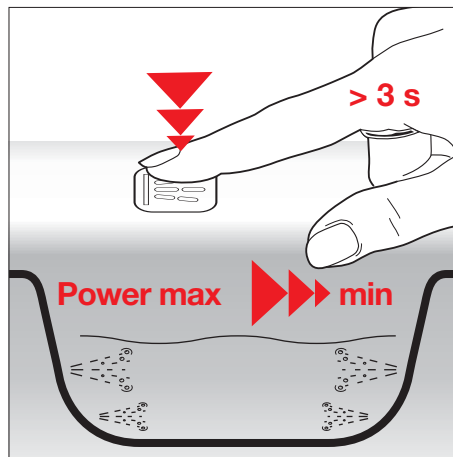

### OFF

Note: the water massage turns automatically off after 20 minutes of operation.

**Alarm:** if there is not enough water in the bathtub, this alarm will be activated. Please fill more water into the tub, so that the water level is at least 20 mm above the highest nozzle.

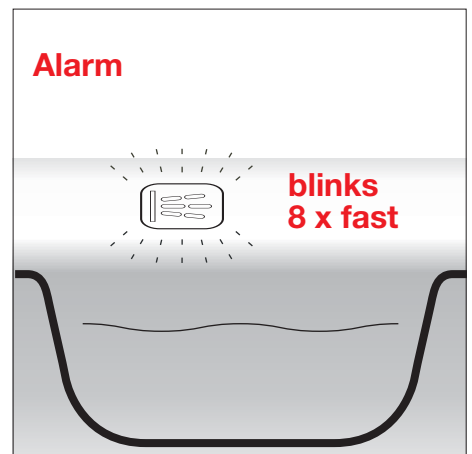
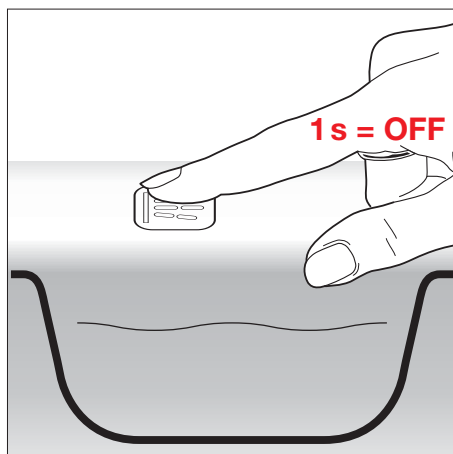

# LED Light

## ON = multicolour



### Multicolour:

- 10 s white..... (W)
- 10 s yellow ..... (Y)
- 10 s orange ..... (O)
- 10 s blue ..... (B)
- 10 s green ..... (G)
- 10 s red..... (R)

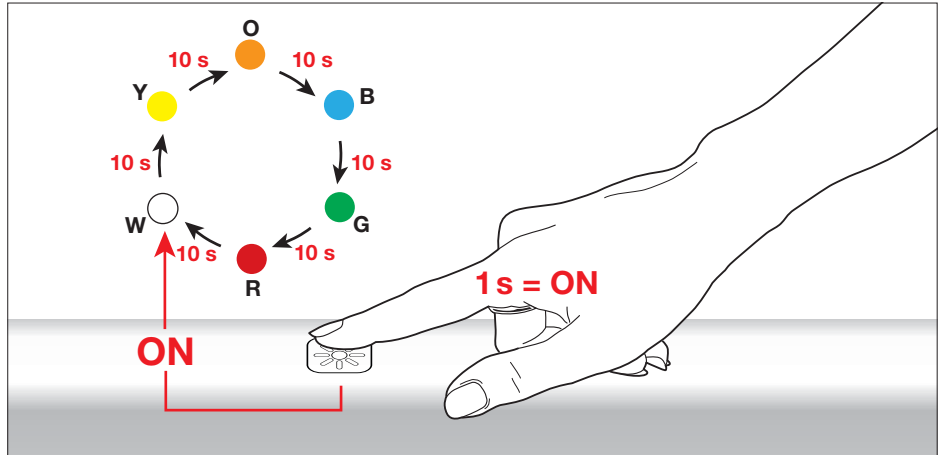

## Choose colour

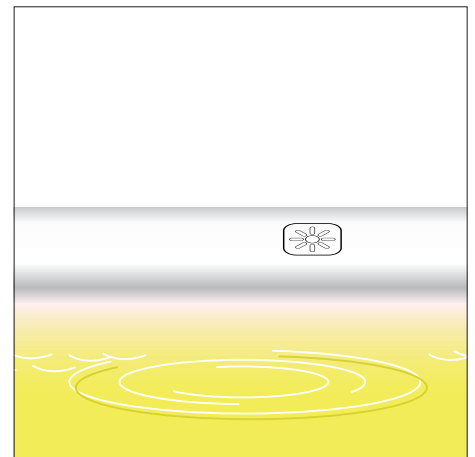
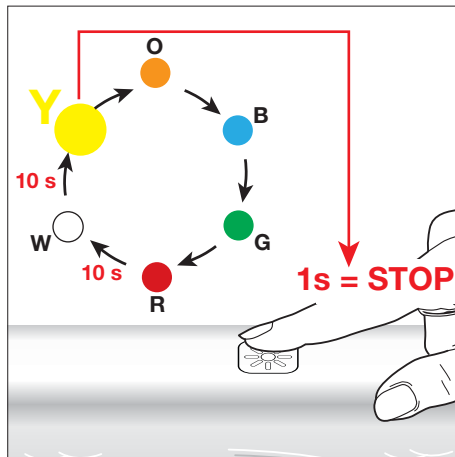

## Change colour

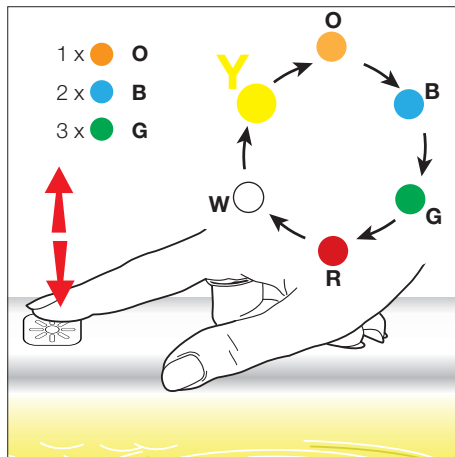

## OFF

Please note that the LED of the LED light icon is always lit, even when the tub is not in operation.

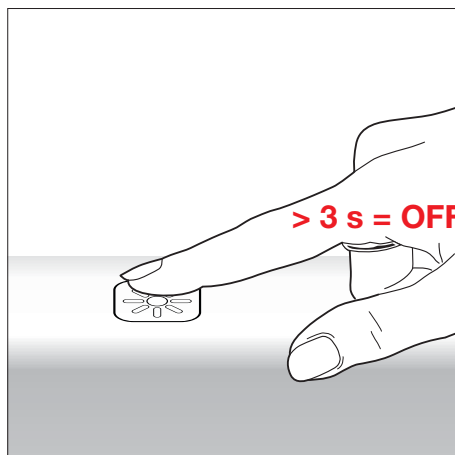



## Fog function



Use only distilled water for the fog function. Other fluids can cause deposits which would affect the function. We recommend using Laufen essences exclusively for aromatherapy, Item Number 2.9980.0.000.000.1. Mix the distilled water with your desired essence in the ratio 1:20.

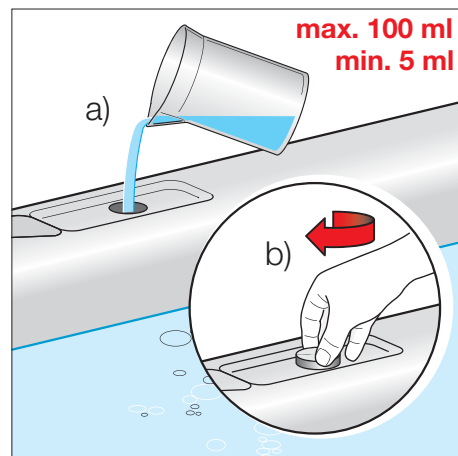
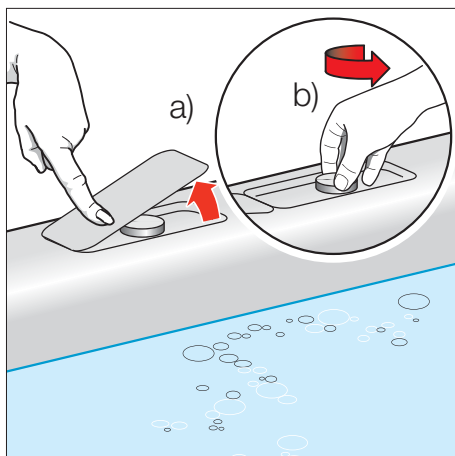

### ON

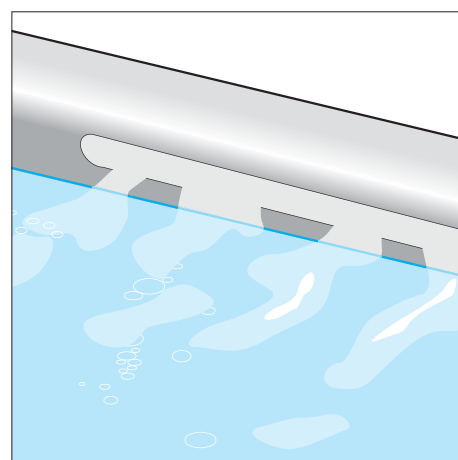
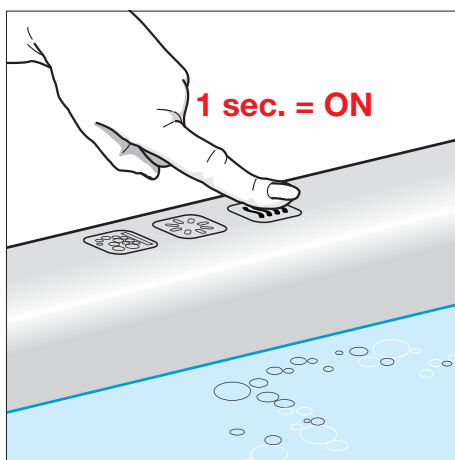

### OFF

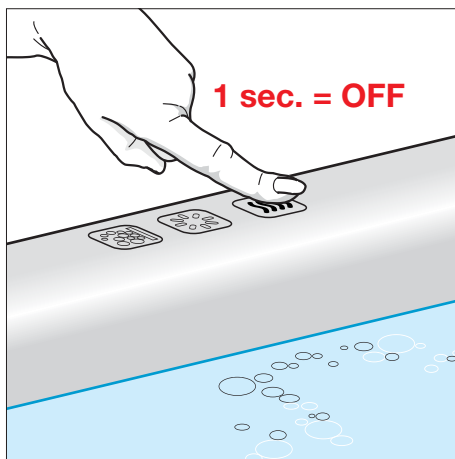

### Tank draining and display

Drain the tank at regular intervals. If you change between various different essences you should drain the tank every time and refill it with fresh distilled water. If the sensor at the edge of the bath is flashing, then the tank needs refilling.

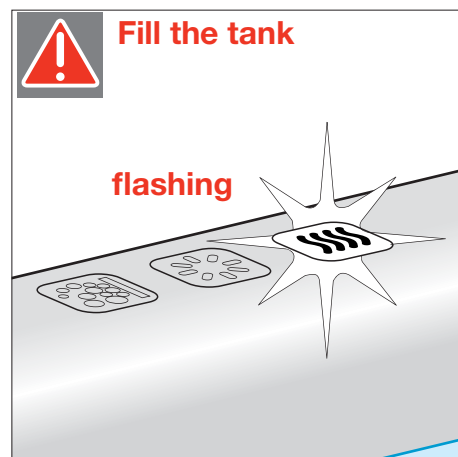
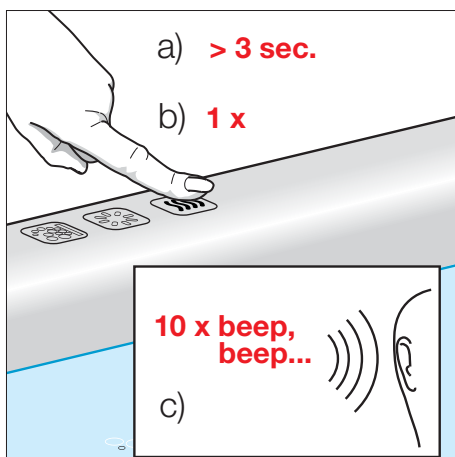



The automatic disinfection function (only for option 695) allows you to disinfect your LAUFEN bathtub. Start a disinfection cycle to clean the tub before its first use and then regularly after every third usage and after long periods of inactivity (more than 3 weeks).

### Disinfection reminder

A built-in timer counts the days since executing the last disinfection cycle. After 7 days, the LED of the disinfection icon will remind you that a new disinfection is necessary.

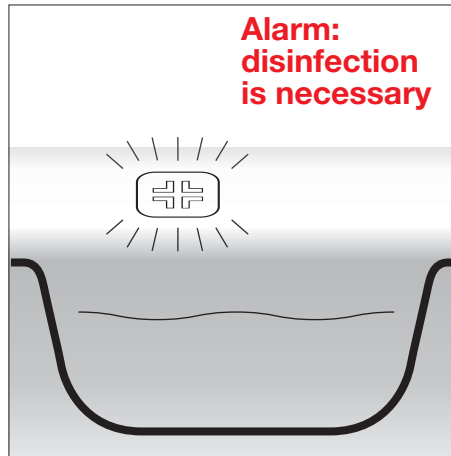

### Requirements for disinfection cycle

- Air massage, water massage and LED light are OFF
- Water level is above minimum (at least 2 cm above the highest water nozzle)
- Enough disinfection liquid is in the tank

### ON

Please note that you have to press the button 6 times within a period of 10 seconds.

You can stop the disinfection only by cutting off the power supply of the bathtub.

After disinfecting, you have to empty the bathtub and the drying system is activated automatically. Once the drying process finishes, the control buttons of the bathtub are unblocked and you can operate the tub normally.

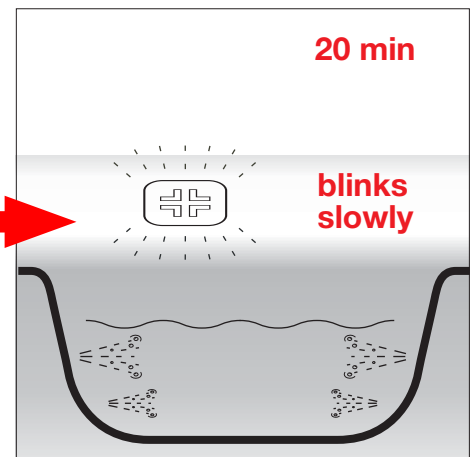
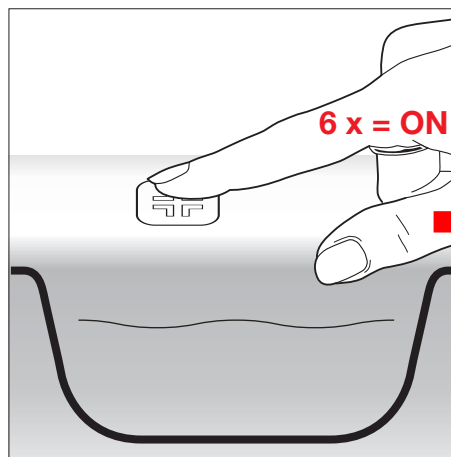

### Disinfection cannot start

The disinfection cycle cannot start because the according requirements are not met (see above).

Please check the requirements and correct if necessary.

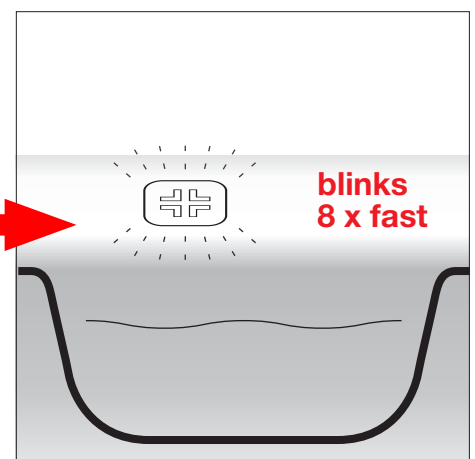
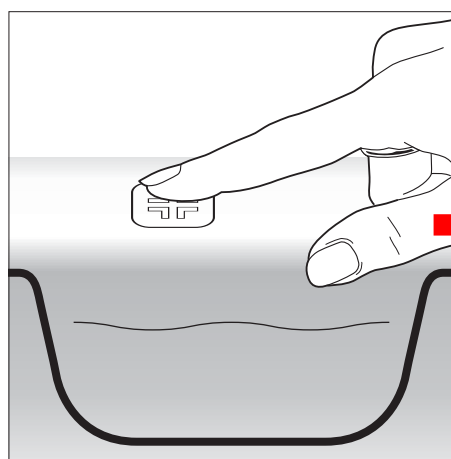

## Manual Disinfection

Manual disinfection (only for options 605, 615, 616, 625, 627, 635, 645 and 675) allows you to disinfect your LAUFEN bathtub. Realise a disinfection cycle to clean the tub before its first use and then regularly after every third usage and after long periods of inactivity (more than 3 weeks).

Steps for disinfection:

1. Pour at least 50 ml of disinfection liquid into the filled tub.
2. Run the water massage function for about 5 minutes.
3. Wait 10 minutes.
4. Repeat steps 2 and 3 twice more.
5. Drain the tub.

We generally recommend our specially adapted LAUFEN TOP disinfectant (art. no. 2.9504.7.000.000.1).

Third-party products: use only "whirlpool-compatible" disinfectants and bath additives.

## Malfunctions



In the event of malfunctions in your bath, allow only qualified technicians to service it. Consult the following chart and if necessary, contact your local LAUFEN dealer.

Malfunctions	Possible cause	Solution
LED light does not work / Air massage or water massage do not start The multicolour function does not change colour / The LED light does not switch off / The intensity of the blower can not be changed / The blower does not stop	There is no voltage input in the electronic box (230 V AC)	Check all electrical connections
	The contact with the sensor is inadequate	Try to cover a larger area of the sensor with the thumb
	Sensor is damaged	Please contact your local LAUFEN dealer for service. The sensor must be replaced
	Electronic box is damaged	Please contact your local LAUFEN dealer for service. The electronic box must be replaced)
Nozzles do not work although the water massage is turned on	Nozzles are clogged	Clean the nozzles manually as described in the chapter "Service Instructions"
Water massage does not start (button blinks fast) even if the bathtub is filled and the water level is correct	Failure of the water level sensor	Please contact your local LAUFEN dealer for service
The misting LED on the rim of the bath is flashing	The tank is empty	Top up the tank with max. 100 ml distilled water. Turn off the mist function. Start the function again to assure that water level is correct.
Fog not being emitted	- The tank valve is not closing after draining - The fan on the fog generator is defective - The generator is defective	For servicing please contact your local LAUFEN sales dealer



### Refilling the disinfection tank for automatic disinfection (option 695 only)

Follow the steps as shown in picture 1:

Unscrew and remove the cap of the disinfection tank.

Pour at least 50 ml of disinfection liquid into the tank. We generally recommend our specially adapted LAUFEN TOP disinfectant art. no. 2.9504.7.000.000.1. Third-party products: use only "whirlpool-compatible" disinfectants.

Reattach and screw the cap.

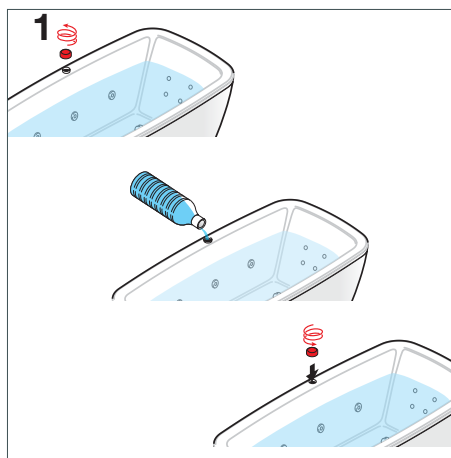

### Cleaning the water massage nozzles

If the nozzles of the water massage are clogged, it is necessary to clean them manually. You must remove the nozzles for cleaning.

In order to remove the nozzle, unscrew it by turning it anti-clockwise as shown in picture 3. When you feel a resistance, unlatch it by turning further.

Clean the nozzle by flushing it out with cold water.

After cleaning the nozzle, screw it back into its nozzle holder by turning it clockwise as shown in picture 3.

Please note that these instructions refer to exclusive water jets only (see "Types of water nozzles" in the chapter "Preliminary Operations"). Basic water jets normally do not clog. If they do not operate properly anyway, please contact your local LAUFEN dealer for technical service.

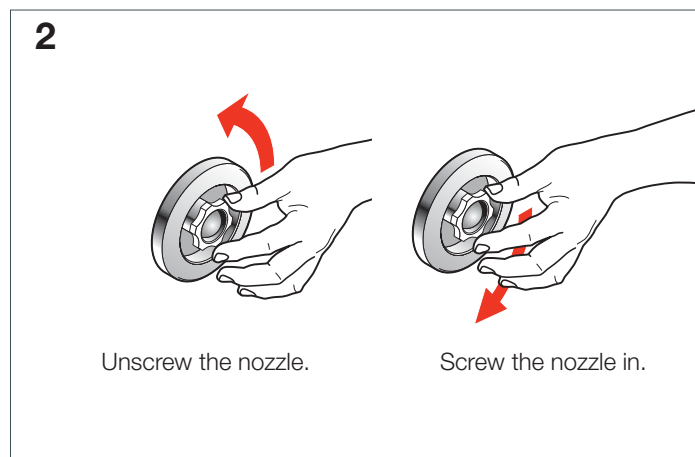

Unscrew the nozzle.

Screw the nozzle in.

# LAUFEN

Laufen Bathrooms AG  
 Wahlenstrasse 46  
 CH-4242 Laufen, Switzerland  
 www.laufen.com