

ART. COD.

**Q 11 L**

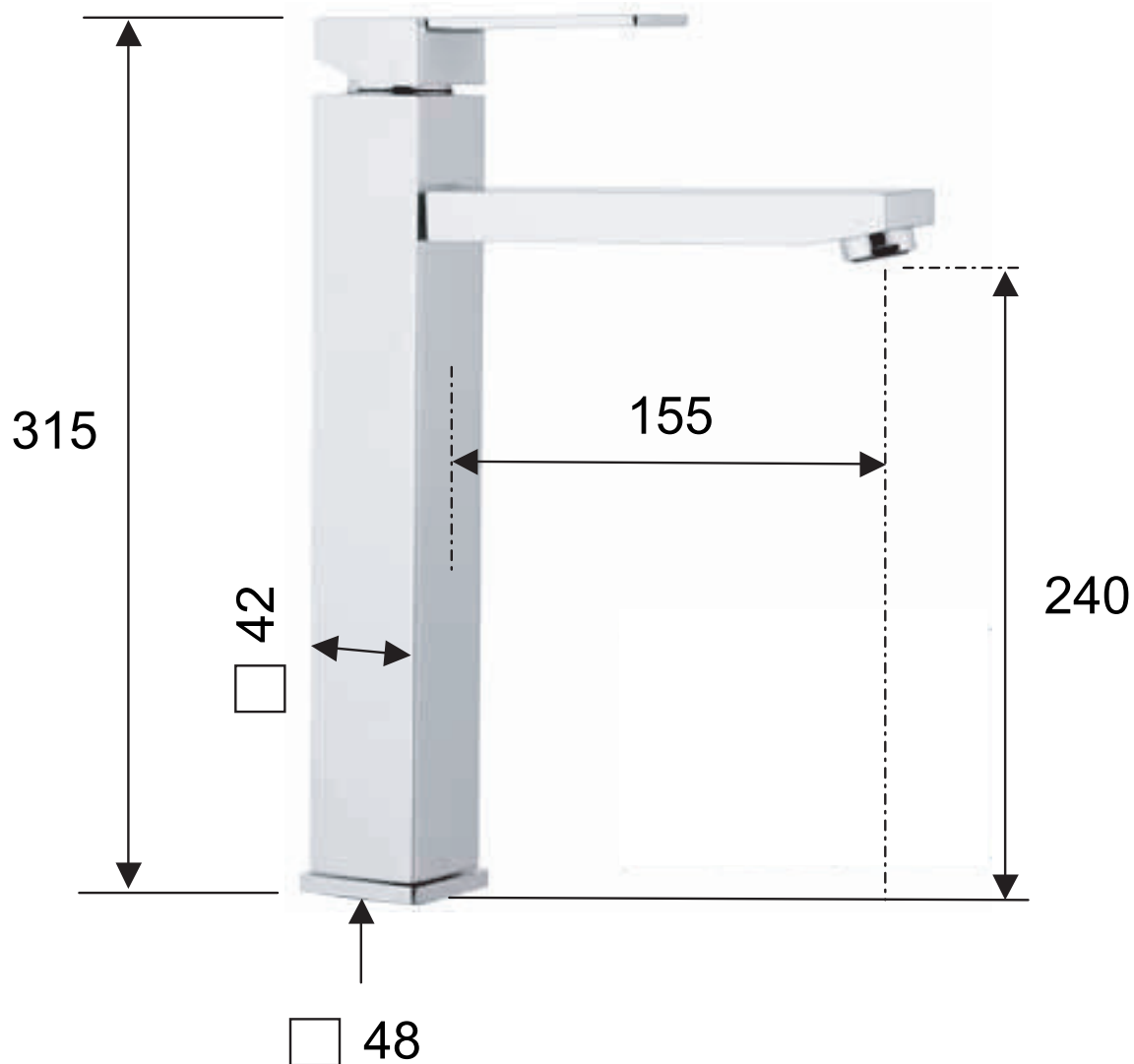

**MATERIALI / MATERIALS**

OTTONE CROMATO / CHROME PLATED BRASS

**CROMATURA / CHROME PLATING**

UNI EN 248

Via Leonardo da Vinci 83 - 20062 Cassano d'Adda (MI) Italy - Tel. +39-0363 364211

[info@remer.eu](mailto:info@remer.eu) [www.remer.eu](http://www.remer.eu)